

SCM D228

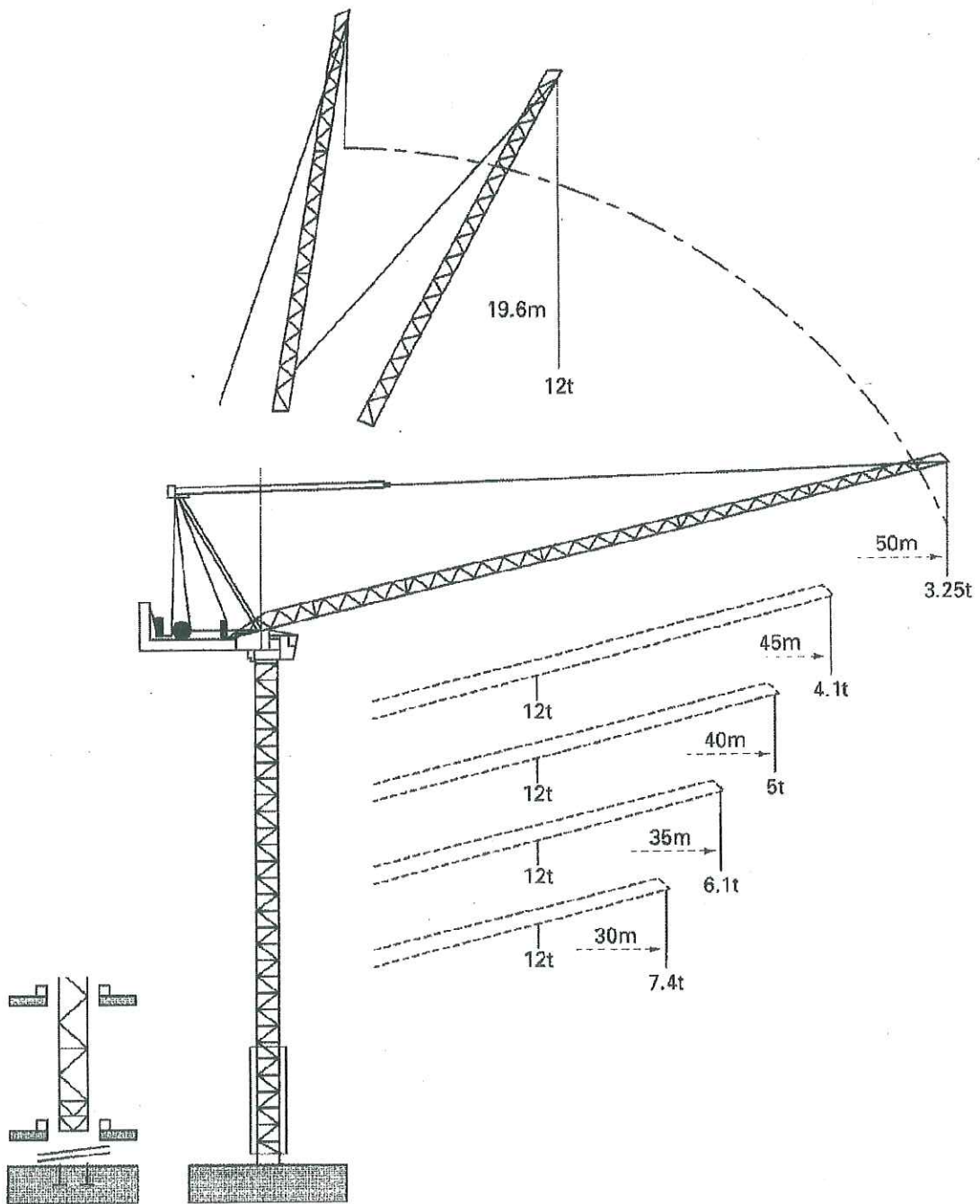

SCM





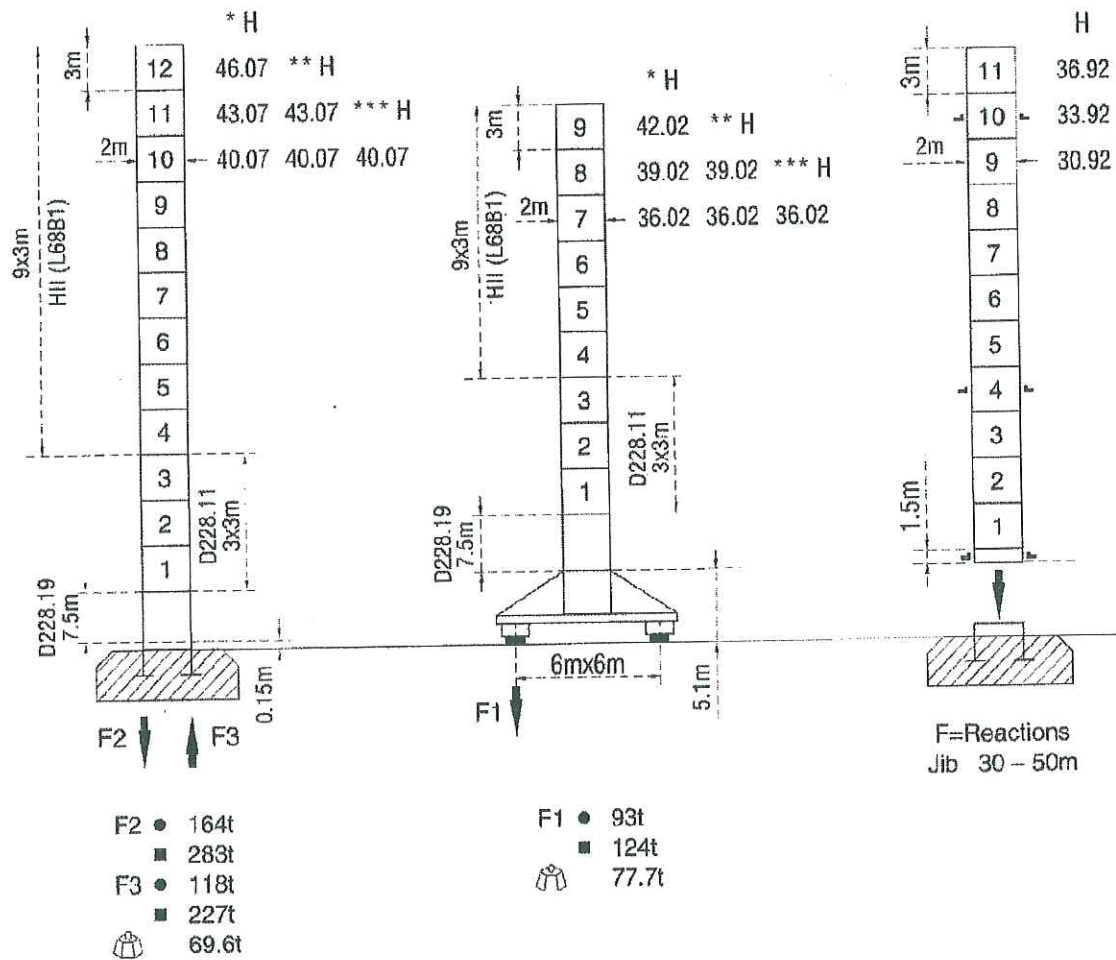



D228 DIMENSIONS

Mast 2m x 2m



- Reaction in Service
- Reaction Out of Service
- ⚖ Without load and ballast with maximum jib and maximum height

D228 Specification (Mechanisms)

								ch - PS hp	kW	
	70RCS	12t	m/min	40	80	20	40	70	51.5	533m
	30		t	6	3	12	6			
	40BWZAB		m/min	≈ 3.0min				41	30	
	OMD55		r/min	0 → 0.7				2x8	2x6	
	RCV120		r/min	0 → 0.7						2x185N.m
	RT433		m/min	12.5 → 25				4x2.3/4.7	4x1.7/3.4	

SCM TOWER CRANES

Manufacturer
Sichuan Construction Machinery
(Group) Co., Ltd.

SCM D228