

DWT 1475 대우 타워 크레인

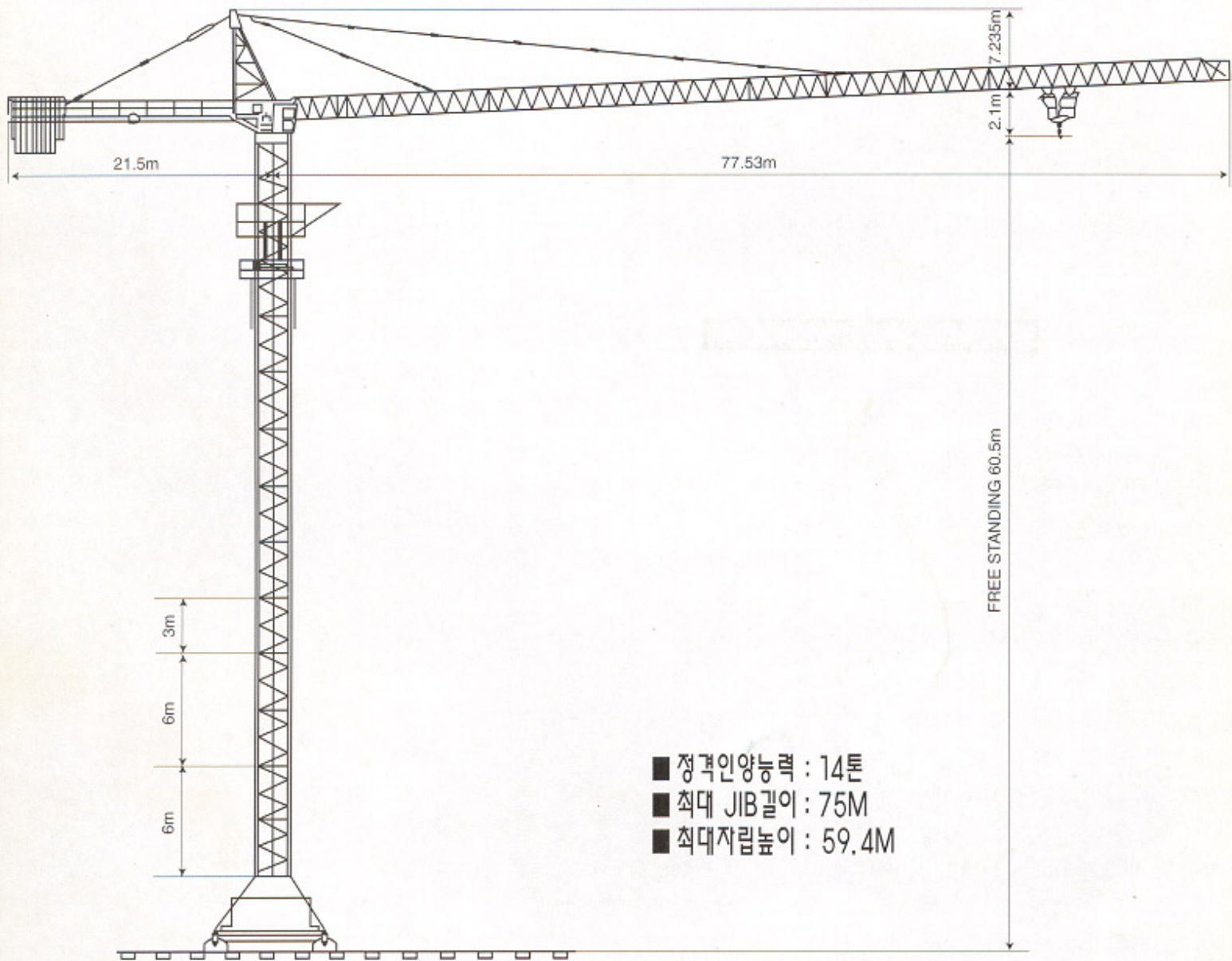

- 정격인양능력 : 14톤
- 최대 JIB길이 : 75M
- 최대자립높이 : 59.4M

■ 설치 형태별 종류

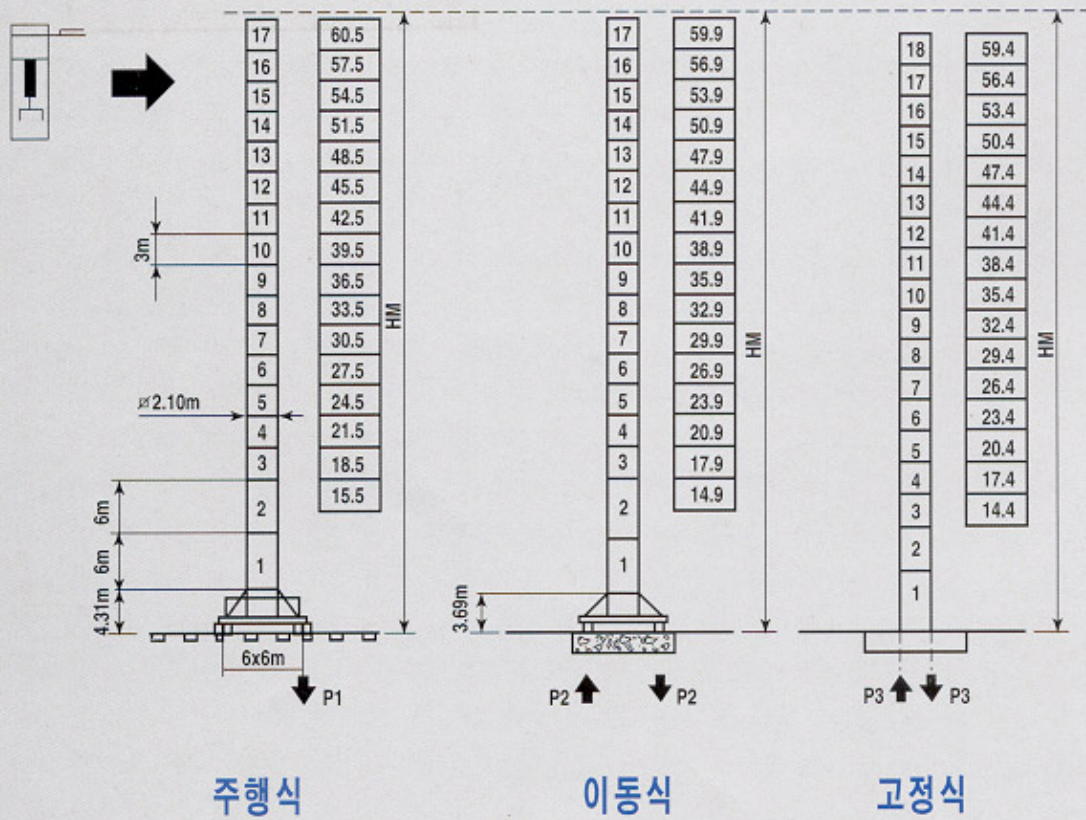
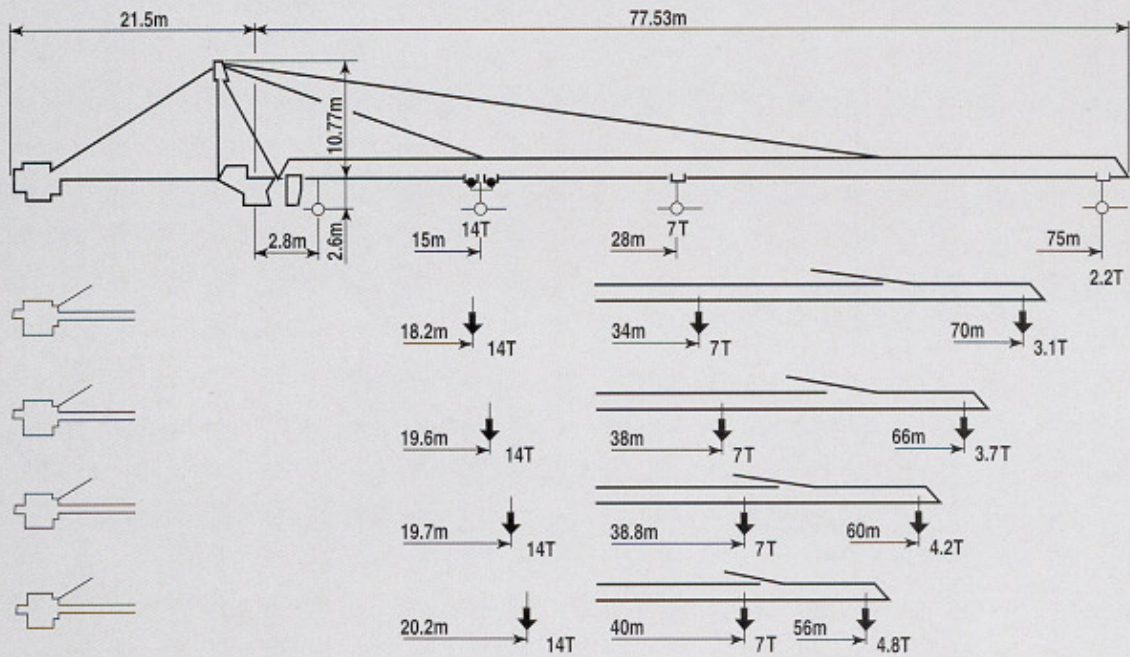

DAEWOO

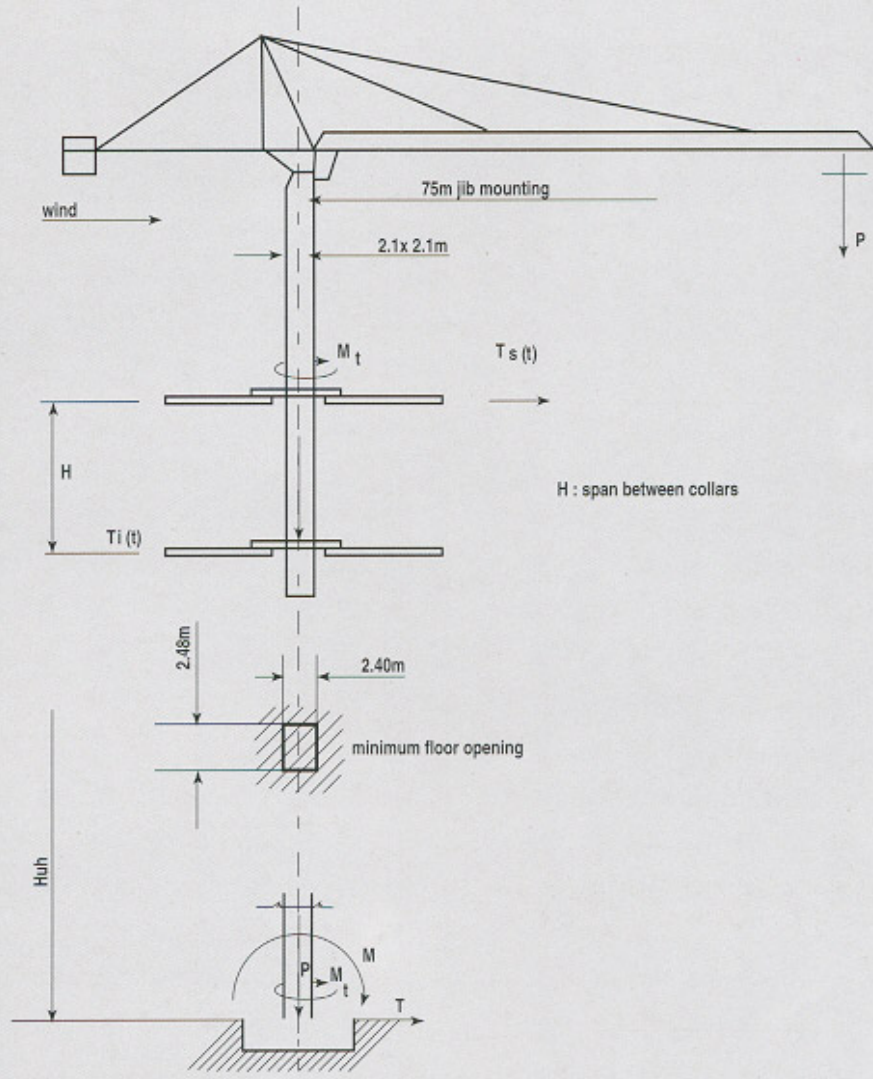

Huh(m)	H(m)	9	10	11	12	13	14	15	16
		Ts	19.3	17.3	15.7				
	Ti	17.6	15.7	14.1					
30.9	Ts	20.1	18.0	16.3	14.9				
	Ti	18.2	16.2	14.6	13.2				
33.9	Ts	20.8	18.7	17.0	15.5	14.3	13.2		
	Ti	18.9	16.8	15.1	13.7	12.5	11.5		
36.9	Ts	21.7	19.5	17.6	16.1	14.8	13.7	12.8	
	Ti	19.5	17.4	15.6	14.1	12.9	11.8	10.9	
39.9	Ts		20.3	18.4	16.8	15.4	14.3	13.3	12.4
	Ti		18.0	16.2	14.7	13.4	12.3	11.3	10.5
42.9	Ts		21.1	19.1	17.5	16.1	14.9	13.9	12.9
	Ti		18.7	16.8	15.2	13.9	12.7	11.7	10.9

상승식 (Floor Climbing Type)

TOWER CRANE

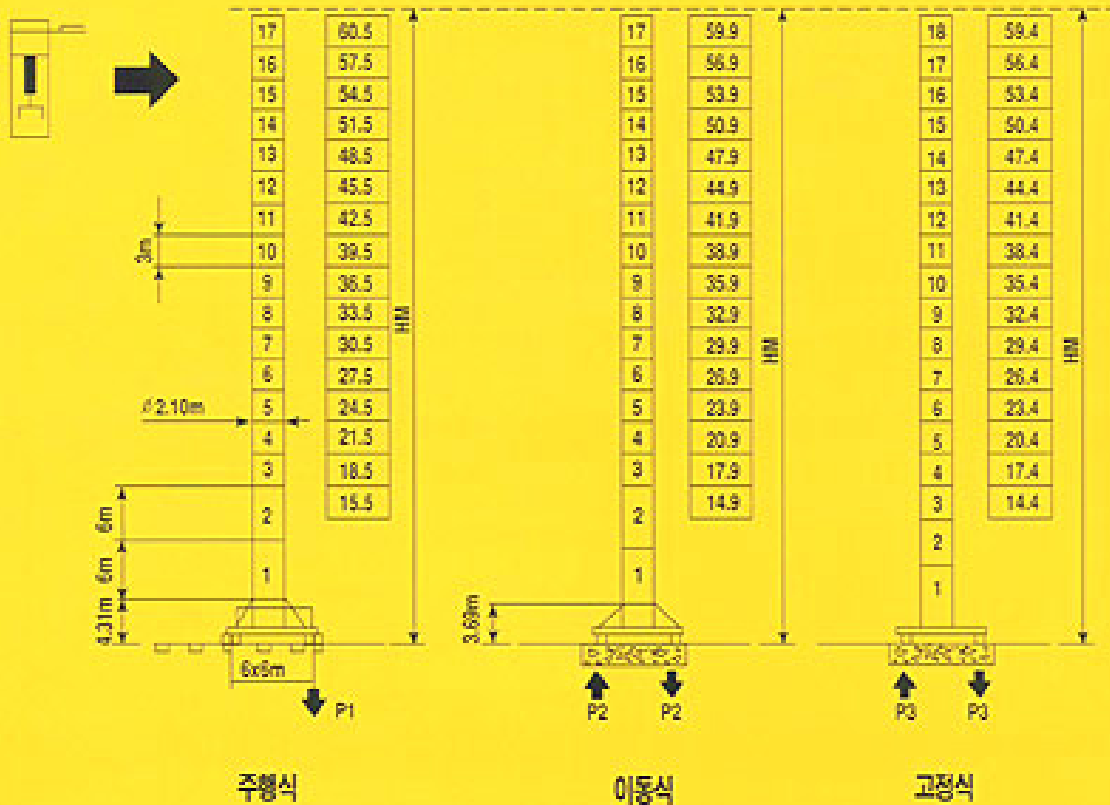
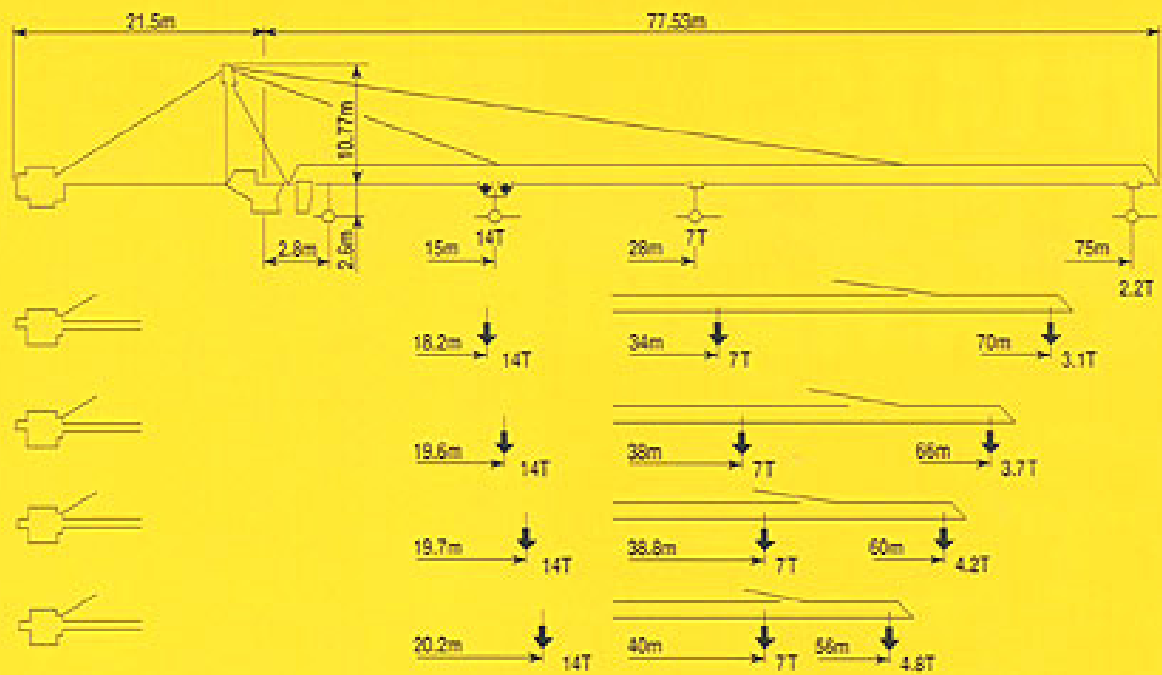

DAEWOO

■ 상승형 (Floor Climbing Type)

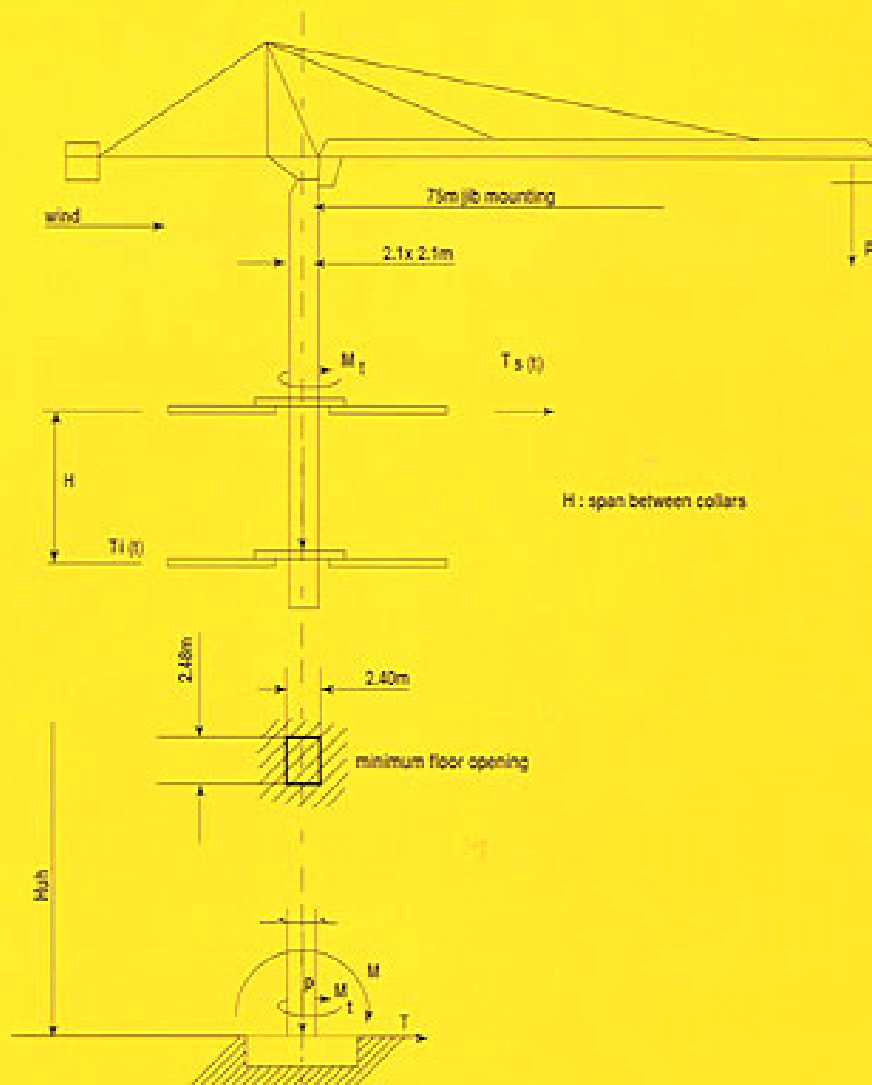

$H_{uh}(m)$	$H(m)$	9	10	11	12	13	14	15	16
30.9	T_s	19.3	17.3	15.7					
	T_i	17.6	15.7	14.1					
33.9	T_s	20.1	18.0	16.3	14.9				
	T_i	18.2	16.2	14.6	13.2				
36.9	T_s	20.8	18.7	17.0	15.5	14.3	13.2		
	T_i	18.9	16.8	15.1	13.7	12.5	11.5		
39.9	T_s	21.7	19.5	17.6	16.1	14.8	13.7	12.8	
	T_i	19.5	17.4	15.6	14.1	12.9	11.8	10.9	
42.9	T_s		20.3	18.4	16.8	15.4	14.3	13.3	12.4
	T_i		18.0	16.2	14.7	13.4	12.3	11.3	10.5
45.9	T_s		21.1	19.1	17.5	16.1	14.9	13.9	12.9
	T_i		18.7	16.8	15.2	13.9	12.7	11.7	10.9

TOWER CRANE

작업반경 및 정격인양능력										단위 : kg
WATER	75M	70M	66M	60M	56M	50M	46M	40M	36M	
15	14,000	14,000	14,000	14,000	14,000	14,000	14,000	14,000	14,000	
16	13,006	14,000	14,000	14,000	14,000	14,000	14,000	14,000	14,000	
17	12,120	14,000	14,000	14,000	14,000	14,000	14,000	14,000	14,000	
18	11,338	14,000	14,000	14,000	14,000	14,000	14,000	14,000	14,000	
19	10,643	13,294	14,000	14,000	14,000	14,000	14,000	14,000	14,000	
20	10,021	12,533	13,791	13,962	14,000	14,000	14,000	14,000	14,000	
21	9,461	11,848	13,043	13,205	13,880	14,000	14,000	14,000	14,000	
22	8,955	11,227	12,366	12,521	13,163	13,699	13,985	14,000	14,000	
23	8,494	10,644	11,750	11,898	12,512	13,023	13,296	13,848	14,000	
24	8,074	10,149	11,188	11,330	11,917	12,406	12,667	13,195	13,700	
25	7,689	9,677	10,673	10,809	11,371	11,840	12,090	12,597	13,080	
26	7,334	9,243	10,199	10,329	10,869	11,320	11,560	12,046	12,510	
27	7,007	8,842	9,762	9,887	10,406	10,839	11,070	11,537	11,983	
28	7,000	8,471	9,357	9,477	9,977	10,394	10,616	11,066	11,496	
29	6,919	8,127	8,981	9,097	9,579	9,981	10,195	10,629	11,044	
30	6,657	7,806	8,630	8,743	9,208	9,596	9,803	10,222	10,622	
31	6,413	7,507	8,304	8,412	8,862	9,237	9,437	9,842	10,229	
32	6,184	7,227	7,998	8,103	8,538	8,901	9,095	9,487	9,861	
33	5,970	7,127	7,711	7,813	8,235	8,586	8,774	9,154	9,516	
34	5,769	7,000	7,442	7,541	7,950	8,291	8,473	8,841	9,192	
35	5,579	6,983	7,189	7,284	7,681	8,012	8,189	8,546	8,887	
36	5,401	6,764	7,000	7,043	7,428	7,750	7,921	8,269	8,600	
37	5,232	6,558	7,000	7,000	7,189	7,502	7,669	8,006		
38	5,072	6,362	7,000	7,000	7,000	7,267	7,430	7,758		
39	4,921	6,177	6,807	6,893	7,000	7,045	7,203	7,523		
40	4,778	6,002	6,615	6,699	7,000	7,000	7,000	7,300		
41	4,641	5,835	6,433	6,514	6,852	7,000	7,000			
42	4,512	5,676	6,259	6,339	6,669	6,943	7,000			
43	4,388	5,525	6,094	6,172	6,494	6,762	6,905			
44	4,271	5,381	5,937	6,013	6,327	6,589	6,729			
45	4,158	5,243	5,787	5,861	6,168	6,424	6,561			
46	4,051	5,112	5,643	5,716	6,016	6,266	6,400			
47	3,948	4,986	5,506	5,577	5,871	6,116				
48	3,850	4,866	5,374	5,444	5,731	5,971				
49	3,756	4,750	5,249	5,317	5,598	5,833				
50	3,665	4,640	5,128	5,194	5,470	5,700				
51	3,579	4,533	5,012	5,077	5,347					
52	3,495	4,431	4,900	4,964	5,229					
53	3,415	4,333	4,793	4,856	5,116					
54	3,338	4,239	4,690	4,752	5,007					
55	3,264	4,148	4,591	4,651	4,901					
56	3,192	4,060	4,495	4,554	4,800					
57	3,123	3,976	4,403	4,461						
58	3,057	3,894	4,314	4,371						
59	2,992	3,815	4,228	4,284						
60	2,930	3,739	4,145	4,200						
61	2,870	3,666	4,064							
62	2,812	3,595	3,987							
63	2,756	3,526	3,912							
64	2,702	3,459	3,839							
65	2,649	3,395	3,768							
66	2,598	3,332	3,700							
67	2,548	3,271								
68	2,500	3,213								
69	2,453	3,155								
70	2,408	3,100								
71	2,364									
72	2,321									
73	2,280									
74	2,239									
75	2,200									

단위 : kg

정격인양능력

정격인양능력

	0~67m/min	6.6kw
	0~0.96rpm	4 x 4kw
	0~23m/min	4 x 6.5HP
	소요전력 83kw	
	자체중량 70TON	
	레일종류 (Rail type) 46.3kg/m	
	최대인양여중 -	최대압축여중 87.2T
P1	-	87.2T
P2	28.9T	69.4T
P3	114.1T	151.5T

호이스트 원치 성능도

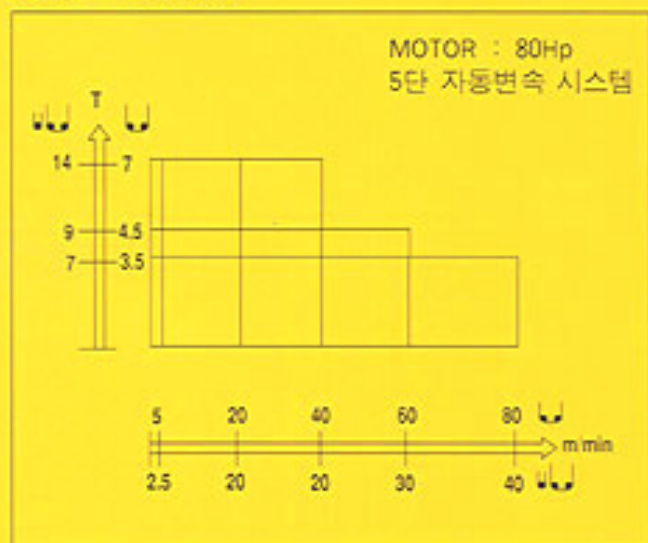

*상기 제품들은 성능개선을 위하여 예고없이 변경될수 있습니다.